

SELECTSET
AVANTRA
Imagewriter Family

44

**Large format
imagesetting solutions**

SelectSet Avantra 44 is an industry-leading, large-format PostScript imagesetter family that gives prepress and printing professionals the quality, reliability, and capabilities they need. Agfa recognizes that prepress and printing operations have different needs and budgets, so there are three models to choose from, offering different levels of quality. Each Avantra 44 imagesetter offers a generous 36x44.5" (914 x 1130mm) format that matches most large-format presses. And all are extremely easy to operate, with a user-friendly touch-screen control panel and an extremely ergonomic design.

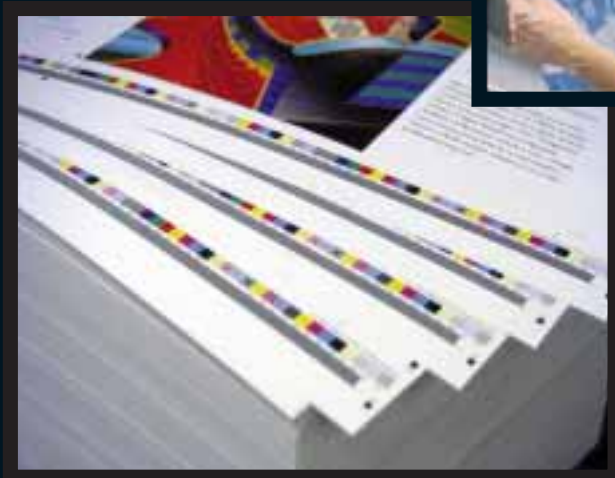

AGFA 
The complete picture.

Meet the SelectSet Avantra 44 family



The award-winning SelectSet Avantra 44 is now available in three models — the high-performance Avantra 44XT, the high-quality Avantra 44S, and the high-value Avantra 44E.

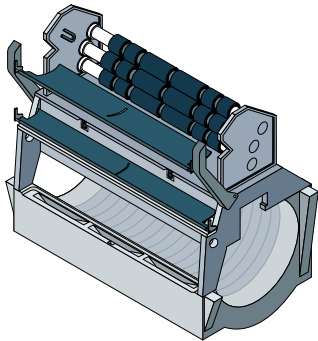

Accuracy starts with SelectSet Avantra's internal drum, where precision engineering and flawless finishing keep the media lying perfectly flat, ensuring consistent media exposure across the entire image area.

With the SelectSet Avantra 44 family, there is a model that meets your quality and throughput needs today—and in the future. Plus, only Agfa offers a single point of contact for all key prepress elements, including imagesetters, RIPs, screening, media, and processing. And Agfa's state-of-the-art service and responsive support ensure great results.

All SelectSet Avantra 44 models include the features that have made the SelectSet Avantra family the world's leading family of internal drum imagesetters: **IntelliTrack™** Agfa's patented transport system, ensures precise motion and consistent, artifact-free output; Agfa **OptiSpot™** technology adjusts the spot size to eliminate dot gain, even at the highest resolutions; **OptiFocus™** automatically adjusts the system to accommodate different media thicknesses; **FlexMedia™** lets you use any width media, eliminating waste; to facilitate media handling, SelectSet Avantra 44 imagesetters feature **EasyLoad**, a hydraulic loading system that makes it easy to load input cassettes. All SelectSet Avantra 44 imagesetters integrate seamlessly with an optional SelectSet Avantra OLP on-line processor.

Supporting the move to an all-digital workflow

Each member of the SelectSet Avantra 44 family can handle a range of media thicknesses — including 4 mil, 8 mil, and 12 mil — allowing output of both film and Setprint polyester plate material. So any model can double as a platesetter (or duosetter) in a turnkey SelectPlate polyester platesetting configuration. An Avantra 44 imagesetter can expose Setprint polyester plates at resolutions up to 150 lines per inch for short-run spot color and black-and-white applications. And for longer runs, it can output film at higher line screens. A Setprint configuration offers a low-risk, flexible way to begin to benefit from streamlined computer-to-plate output, while putting an all-digital workflow in place.

Options that fit your needs and match your budget

You can choose from three SelectSet Avantra 44 models — the high-performance Avantra 44XT, the high-quality Avantra 44S, and the high-value Avantra 44E. All offer a set of features designed to meet specific resolution and throughput needs, while emphasizing the quality, speed, and other innovations that are the hallmarks of the SelectSet Avantra family.

Printing Press	Plate Format (mm)	Plate Format (inch)
Heidelberg Speedmaster 102	770 x 1030	30.3 x 40.6
MAN Roland 600/700	784 x 1030	30.9 x 40.6
Komori Lithrone 40	800 x 1030	31.5 x 40.6
Komori Lithrone 44	902 x 1130	33.5 x 44.5
Agfa SelectSet Avantra 44	914 x 1130	36 x 44.5

SelectSet Avantra 44 models lets you output eight imposed pages with plenty of room for trimming and finishing. Its generous 44.5" width provides a wide range of options for final gathering, folding, and binding.

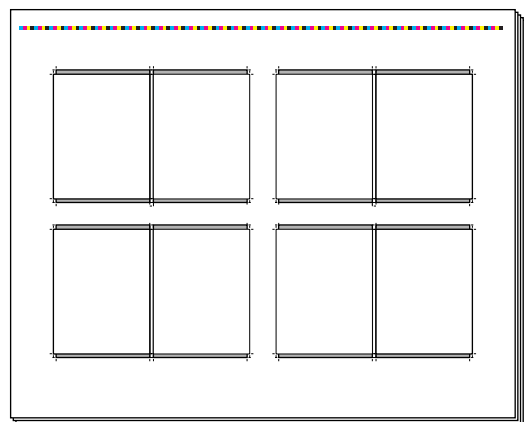

	Avantra 44E	Avantra 44S	Avantra 44XT
Imaging area	35.7 x 44.5" (906 x 1130 mm)	35.7 x 44.5" (906 x 1130 mm)	35.7 x 44.5" (906 x 1130 mm)
Resolution	1200, 1800, and 2400 dpi	1200, 1800, 2400, and 3600 dpi	900, 1200, 1800, and 2400 dpi
Spot sizes	20 μ , 15 μ	20 μ , 15 μ , 10 μ , 7.5 μ	25 μ , 20 μ , 15 μ
Imaging speed	742 sq."/min.(4787 cm ² /min.) at 1200 dpi	742 sq."/min.(4787 cm ² /min.) at 1200 dpi	1113 sq."/min.(7181 cm ² /min.) at 1200 dpi
Maximum line screen	200 lpi (78 lines/cm)	425 lpi (167 lines/cm)	200 lpi (78 lines/cm)

SelectSet Avantra 44XT

The high-performance leader for fast throughput

Avantra 44XT is designed specifically for customers who need fast throughput for books and other long page-count documents. Fueled by a 30,000 rpm spin motor, the SelectSet Avantra XT can output 21 full flats per hour at 1200 dpi—50 percent faster than the Avantra 44S. Avantra 44XT lets you output standard-resolution jobs quickly. And thanks to the special Avantra automation features, these jobs are completed without delays or interruptions in the process.

Avantra 44XT also features a high-performance media handling system to support the high-throughput capabilities of the imaging engine. With its high-speed, 8-up imaging system and high-performance automated media handling—Avantra 44XT is perfect for a wide range of production-oriented applications.

SelectSet Avantra 44S

The high-quality, large-format imagesetter solution

SelectSet Avantra 44S—the flagship imagesetter of the SelectSet Avantra line—provides the highest resolution available in an 8-up, large-format imagesetter—along with all the quality and performance features of the Avantra product line. SelectSet Avantra 44S is the right choice for imaging jobs such as magazines, posters, brochures, ads, catalogs, and other applications that require high-quality output.

SelectSet Avantra 44S features a high-speed, 20,000 rpm spin motor, and offers the highest level of precision available—enabling duplo and quadro four-color imaging. Now color trade shops and commercial printers requiring high-quality imaging output in an 8-up format can complete more jobs in less time, boosting productivity and achieving a faster return on their imagesetter investment. SelectSet Avantra 44S offers four resolutions (1200, 1800, 2400, and 3600 dpi), full linearity, OptiSpot at all resolutions, and CristalRaster screening. The result? The highest levels of imaging and reproduction quality available.

SelectSet Avantra 44E

An high-value approach to large-format imagesetting

SelectSet Avantra 44E is a large-format imagesetter that fits well within a limited budget, while still providing remarkable performance and value. Customers with large-format applications requiring up to 200 lpi should consider this member of the Avantra 44 family. SelectSet Avantra 44E can image at three resolutions—1200, 1800, and 2400 dpi with OptiSpot optimization at 1200 and 1800 dpi.

SelectSet Avantra 44E is the preferred system for use with Agfa Setprint polyester plate material. Setprint enables the Avantra 44E to output press-ready plate media for a range of applications, including shoppers, checks, newsletters, packaging, and tags and labels.

Choose a SelectSet Avantra 44 today

With three exceptional models to choose from, there's a SelectSet Avantra 44 imagesetter that is right for your business. And as your business grows and your needs change, simple system upgrades make it easy to add new capabilities. When you buy an Agfa imagesetter, you are making a quality investment that will continue to pay off well into the future. And that's just one of the reasons why Agfa has sold more imagesetters than any other manufacturer.

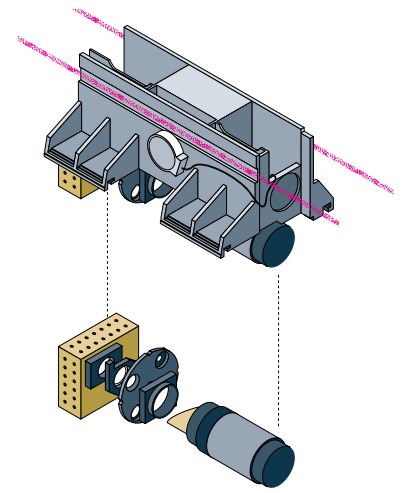





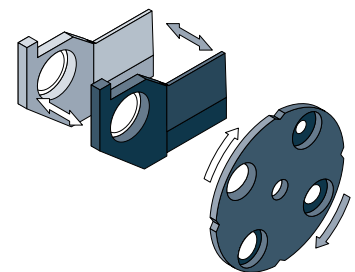



A high-performance, aerodynamic spin motor keeps imaging smooth and accurate—no matter how fast it rotates.

SelectSet Avantra 44 imagesetters can output Alliance film as well as Setprint polyester plate material, enabling them to double as platesetters.



SelectSet Avantra's OptiFocus—a unique, adjustable focus lens—along with OptiSpot—adjusts the spot size to match each resolution.

	Model	SelectSet Avantra 44E	SelectSet Avantra 44S	SelectSet Avantra 44XT																																																																																
	Imaging Technology	Internal drum, 220°	Internal drum, 220°	Internal drum, 220°																																																																																
AVANTRA 44E, 44S, AND 44XT	Maximum Format Size	36 x 44.5" (914 x 1130 mm)	36 x 44.5" (914 x 1130 mm)	36 x 44.5" (914 x 1130 mm)																																																																																
	Maximum Image Area	35.7 x 44.5" (906 x 1130 mm)	35.7 x 44.5" (906 x 1130 mm)	35.7 x 44.5" (906 x 1130 mm)																																																																																
AVANTRA 30E AND 30	Imaging System	Visible red laser diode (650 nm)	Visible red laser diode (650 nm)	Visible red laser diode (650 nm)																																																																																
	Resolutions and Spot Sizes	1200 dpi (472 dots/cm) at 20µ 1800 dpi (708 dots/cm) at 15µ 2400 dpi (945 dots/cm) at 15µ	1200 dpi (472 dots/cm) at 20µ 1800 dpi (708 dots/cm) at 15µ 2400 dpi (945 dots/cm) at 10µ 3600 dpi (1342 dots/cm) at 7.5µ	900 dpi (354 dots/cm) at 25µ 1200 dpi (472 dots/cm) at 20µ 1800 dpi (708 dots/cm) at 15µ 2400 dpi (945 dots/cm) at 15µ																																																																																
AVANTRA 25E, 25S, AND 25XT	OptiSpot	for 1200 and 1800 dpi	for all resolutions	for 900, 1200 and 1800 dpi																																																																																
	Maximum Imaging Speeds	DPI Sq."/min. cm ² /min. Full area 1200 742 4787 2:14 1800 495 3193 3:13 2400 371 2394 4:17	DPI Sq."/min. cm ² /min. Full area 1200 742 4787 2:14 1800 495 3193 3:13 2400 371 2394 4:17 3600 248 1597 6:26	DPI Sq."/min. cm ² /min. Full area 900 1483 9568 1:04 1200 1113 7181 1:26 1800 742 4787 2:14 2400 556 3587 2:51																																																																																
AVANTRA 800, 1000, AND 1500	Maximum Line Screen	200 lpi (78 lines/cm)	425 lpi (167 lines/cm)	200 lpi (78 lines/cm)																																																																																
	Screening Technologies Supported	<ul style="list-style-type: none"> Agfa Balanced Screening Adobe Accurate Screens Standard PostScript RT Screening 	<ul style="list-style-type: none"> Agfa CristalRaster Agfa Balanced Screening Adobe Accurate Screens Standard PostScript RT Screening 	<ul style="list-style-type: none"> Agfa Balanced Screening Adobe Accurate Screens Standard PostScript RT Screening 																																																																																
ANTARES 1000 AND 1000 XT	Media Information Media Types	<ul style="list-style-type: none"> Standard Helium-Neon film and paper (Agfa Alliance HN, HNP) Agfa ZHN, ZHNP in North America; Agfa Setprint polyester plates) 	<ul style="list-style-type: none"> Standard Helium-Neon film and paper (Agfa Alliance HN, HNP) Agfa ZHN, ZHNP in North America; Agfa Setprint polyester plates) 	<ul style="list-style-type: none"> Standard Helium-Neon film and paper (Agfa Alliance HN, HNP) Agfa ZHN, in North America; Agfa Setprint polyester plates) 																																																																																
	Computer to Polyester Plate	12 mil SetPrint	12 mil SetPrint	8 mil SetPrint																																																																																
ANTARES 1600	Media Size	<table border="1"> <thead> <tr> <th>Standard Size</th> <th>RC Paper</th> <th>Film Plate</th> </tr> </thead> <tbody> <tr><td>16" (406.4 mm)</td><td>•</td><td>•</td></tr> <tr><td>18" (457.2 mm)</td><td>•</td><td>•</td></tr> <tr><td>22" (558.8 mm)</td><td>•</td><td>•</td></tr> <tr><td>23.6" (600 mm)</td><td>•</td><td>•</td></tr> <tr><td>24" (609.6 mm)</td><td>•</td><td>•</td></tr> <tr><td>26" (660.4 mm)</td><td>•</td><td>•</td></tr> <tr><td>28.5" (724 mm)</td><td>•</td><td>•</td></tr> <tr><td>30" (762.0 mm)</td><td>•</td><td>•</td></tr> <tr><td>36" (914.4 mm)</td><td>•</td><td>•</td></tr> </tbody> </table>	Standard Size	RC Paper	Film Plate	16" (406.4 mm)	•	•	18" (457.2 mm)	•	•	22" (558.8 mm)	•	•	23.6" (600 mm)	•	•	24" (609.6 mm)	•	•	26" (660.4 mm)	•	•	28.5" (724 mm)	•	•	30" (762.0 mm)	•	•	36" (914.4 mm)	•	•	<table border="1"> <thead> <tr> <th>Standard Size</th> <th>RC Paper</th> <th>Film Plate</th> </tr> </thead> <tbody> <tr><td>16" (406.4 mm)</td><td>•</td><td>•</td></tr> <tr><td>18" (457.2 mm)</td><td>•</td><td>•</td></tr> <tr><td>22" (558.8 mm)</td><td>•</td><td>•</td></tr> <tr><td>23.6" (600 mm)</td><td>•</td><td>•</td></tr> <tr><td>24" (609.6 mm)</td><td>•</td><td>•</td></tr> <tr><td>26" (660.4 mm)</td><td>•</td><td>•</td></tr> <tr><td>28.5" (724 mm)</td><td>•</td><td>•</td></tr> <tr><td>30" (762.0 mm)</td><td>•</td><td>•</td></tr> <tr><td>36" (914.4 mm)</td><td>•</td><td>•</td></tr> </tbody> </table>	Standard Size	RC Paper	Film Plate	16" (406.4 mm)	•	•	18" (457.2 mm)	•	•	22" (558.8 mm)	•	•	23.6" (600 mm)	•	•	24" (609.6 mm)	•	•	26" (660.4 mm)	•	•	28.5" (724 mm)	•	•	30" (762.0 mm)	•	•	36" (914.4 mm)	•	•	<table border="1"> <thead> <tr> <th>Standard Size</th> <th>Film Plate</th> </tr> </thead> <tbody> <tr><td>16" (406.4 mm)</td><td>•</td></tr> <tr><td>18" (457.2 mm)</td><td>•</td></tr> <tr><td>22" (558.8 mm)</td><td>•</td></tr> <tr><td>23.6" (600 mm)</td><td>•</td></tr> <tr><td>24" (609.6 mm)</td><td>•</td></tr> <tr><td>26" (660.4 mm)</td><td>•</td></tr> <tr><td>28.5" (724 mm)</td><td>•</td></tr> <tr><td>30" (762.0 mm)</td><td>•</td></tr> <tr><td>36" (914.4 mm)</td><td>•</td></tr> </tbody> </table>	Standard Size	Film Plate	16" (406.4 mm)	•	18" (457.2 mm)	•	22" (558.8 mm)	•	23.6" (600 mm)	•	24" (609.6 mm)	•	26" (660.4 mm)	•	28.5" (724 mm)	•	30" (762.0 mm)	•	36" (914.4 mm)	•
Standard Size	RC Paper	Film Plate																																																																																		
16" (406.4 mm)	•	•																																																																																		
18" (457.2 mm)	•	•																																																																																		
22" (558.8 mm)	•	•																																																																																		
23.6" (600 mm)	•	•																																																																																		
24" (609.6 mm)	•	•																																																																																		
26" (660.4 mm)	•	•																																																																																		
28.5" (724 mm)	•	•																																																																																		
30" (762.0 mm)	•	•																																																																																		
36" (914.4 mm)	•	•																																																																																		
Standard Size	RC Paper	Film Plate																																																																																		
16" (406.4 mm)	•	•																																																																																		
18" (457.2 mm)	•	•																																																																																		
22" (558.8 mm)	•	•																																																																																		
23.6" (600 mm)	•	•																																																																																		
24" (609.6 mm)	•	•																																																																																		
26" (660.4 mm)	•	•																																																																																		
28.5" (724 mm)	•	•																																																																																		
30" (762.0 mm)	•	•																																																																																		
36" (914.4 mm)	•	•																																																																																		
Standard Size	Film Plate																																																																																			
16" (406.4 mm)	•																																																																																			
18" (457.2 mm)	•																																																																																			
22" (558.8 mm)	•																																																																																			
23.6" (600 mm)	•																																																																																			
24" (609.6 mm)	•																																																																																			
26" (660.4 mm)	•																																																																																			
28.5" (724 mm)	•																																																																																			
30" (762.0 mm)	•																																																																																			
36" (914.4 mm)	•																																																																																			
ANTARES 1000 AND 1000 XT	Media Thickness	4 mil to 12 mil (0,10 to 0,30 mm)	4 mil to 12 mil (0,10 to 0,30 mm)	4 mil to 8 mil (0,10 to 0,20 mm)																																																																																
	FlexMedia	Standard	Standard	Standard																																																																																
GALILEO VISIBLE LIGHT AND THERMAL	DualSupply	Standard	Standard	Standard																																																																																
	Punch Registration Systems	Choice between Stoesser or Bacher Control 2000 system featuring head and tail punches	Choice between Stoesser or Bacher Control 2000 system featuring head and tail punches	Choice between Stoesser or Bacher Control 2000 system featuring head and tail punches																																																																																
AGFA POLARIS 100 AND POLARIS 100 XT	System Options	<ul style="list-style-type: none"> Avantra 44 on-line processing system User-definable punch register system available on request Upgrade to Avantra 44S 	<ul style="list-style-type: none"> Avantra 44 on-line processing system User-definable punch register system available on request 	<ul style="list-style-type: none"> Avantra 44 on-line processing system User-definable punch register system available on request 																																																																																
																																																																																				
AGFA MEDIA PRODUCTS																																																																																				

Argentina, (Paraguay and Uruguay), Regional del Plata, Agfa-Gevaert, Argentina S.A. Tel.: 54-1-958-5767/5770, Fax: 54-1-983-5052

Australia, Agfa-Gevaert Ltd. Tel.: 61-3-9264-7711, Fax: 61-3-9264-7895

Austria, Agfa-Gevaert G.m.b.H. Tel.: 43-1-89112-3290, Fax: 43-1-89112-3204

Belgium, Agfa-België N.V. Tel.: 32-3-450-9872, Fax: 32-3-450-9888

Belgium, Agfa-Gevaert N.V., Direct Export Tel.: 32-3-444-7120, Fax: 32-3-444-7119

Belgium, Agfa-Gevaert N.V., European Distribution Center (EDC) Tel.: 32-3-444-7833, Fax: 32-3-444-7840

Brazil, Agfa-Gevaert do Brasil Ltda Tel.: 55-11-5188-6430, Fax: 55-11-5188-6469

Canada, Bayer Corporation, Agfa Division Tel.: 416-241-1110 Ext: 4032, Fax: 416-241-5409

Caribbean and Central America Bayer Corporation, Agfa Division Tel.: 305-592-6522, Fax: 305-593-8521

Chile, (Bolivia, Ecuador, Peru), Agfa-Gevaert Ltda. Tel.: 56-2-360-7600, Fax: 56-2-360-7642

China, Hong Kong - Agfa Hong Kong Ltd. Tel.: 852-2555-9421, Fax: 852-2555-2480

Columbia, Hoechst Columbiana S.A. Tel.: 57-1-410-1077, Fax: 57-1-295-4197

Czech Republic, Bayer s.r.o. divize Agfa Tel.: 420-2-66101-623, Fax: 420-2-66101-699

Denmark, Agfa-Gevaert A/S, Grafiske Systemer Tel.: 45-4326-6766, Fax: 45-4326-6701

Finland, Oy Agfa-Gevaert Ab Graafiset järjestelmät Tel.: 358-9-88781, Fax: 358-9-8878-278

France, Agfa-Gevaert S.A. Tel.: 33-14-099-8855, Fax: 33-14-099-7996

Germany, Agfa Deutschland Vertriebsgesellschaft mbH & Cie. Tel.: 49-221-5717-0, Fax: 49-221-5717-248

Greece, Agfa-Gevaert A.E.B.E. Tel.: 30-1-576-3200, Fax: 30-1-574-4900

Hungary, Bayer Hungaria Kft, Agfa Division Tel.: 361-212-1540, Fax: 361-212-1574

Ireland, Agfa Ltd. Tel.: 353-1-450-6733, Fax: 353-1-456-5267

Italy, Agfa-Gevaert S.p.A. Tel.: 39-2-3074-1, Fax: 39-2-3074-429

Japan, Agfa-Gevaert Ltd. Tel.: 81-3-5704-3140, Fax: 81-3-5704-3089

Korea, Agfa Korea Ltd. Tel.: 82-2-262-4200, Fax: 82-2-274-9764

Luxembourg, Agfa-Gevaert S.A. Tel.: 352-44-20-441, Fax: 352-45-04-37

Malaysia, Agfa Film (Malaysia) Sdn. Bhd. Tel.: 60 3 7574200, Fax: 60 3 7574700

Mexico, Bayer de Mexico S.A. C.V., Agfa Division Tel.: 525-728-3213, Fax: 525-728-3210

Netherlands, Agfa-Gevaert B.V. Tel.: 31-70-413-1211, Fax: 31-70-413-1585

New Zealand, Bayer New Zealand Ltd., Agfa Division Tel.: 64-9-443-5500, Fax: 64-9-443-8855

Norway, Agfa-Gevaert A.S., Grafiske Systemer Tel.: 47-67-06-8800, Fax: 47-67-06-0753

Poland, Agfa Sp. Z.O.O. Tel.: 48-22-636-7576, Fax: 48-22-838-9114

Portugal, Agfa-Gevaert Lda Tel.: 35-11-414-6700 Fax: 35-11-414-6780

Singapore, Bayer Pte. Ltd., Agfa Division Tel.: 65-261-3389, Fax: 65-265-6559

South Africa, Bayer South Africa (Pty.) Ltd., Agfa Division Tel.: 27-11-921-5564, Fax: 27-11-921-5548

Spain, Agfa-Gevaert, S.A. Tel.: 34-3-476-7600, Fax: 34-3-476-7856

Sweden, Agfa-Gevaert AB Tel.: 46-8-793-0100, Fax: 46-8-793-0171

Switzerland, Agfa-Gevaert AG Tel.: 41-1-823-7111, Fax: 41-1-823-7376

Taiwan, Bayer Taiwan Ltd., Agfa Division Tel.: 886-2-2503-9123, Fax: 886-2-2504-4819

UK, Agfa Gevaert Ltd. Tel.: 44-181-231-4200, Fax: 44-181-231-4957

USA, Agfa Corporation Tel.: 800-227-2780, Fax: 908-534-5151

Venezuela, Agfa-Gevaert de Venezuela S.A. Tel.: 58-2-203-9000, Fax: 58-2-239-0477

Internet address:
www.agfahome.com

© Copyright 1998 by Agfa Corporation. All rights reserved. Printed in USA.

98-1067

AGFA and the Agfa rhombus, Agfa Balanced Screening, Apogee, Avantra, and Taipan are trademarks of Agfa Corporation or its affiliates which may be registered in certain jurisdictions.

All product specifications are subject to change without notice. Appearance of equipment ordered may differ from that of equipment shown in photographs.

NEROS

AGFA 

The complete picture.

